



# BAU

DESERTO

CLASS

EXPERIENCIA  
INMOBILIARIA

Descarga nuestra App  
Class Bienes Raíces





Ubicación GMaps

**Calz. Desierto de los Leones 5329, Col. Tetelpan, T. 5545.2555 [www.class.com.mx](http://www.class.com.mx)**





Fachada









Balcón





Recámara

# **DEPARTAMENTOS A TU MEDIDA**

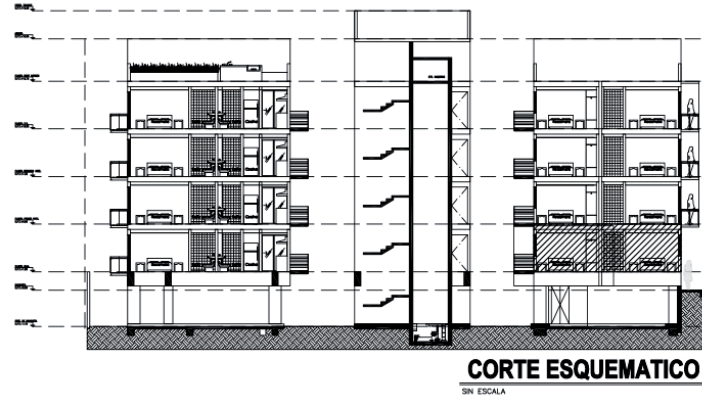
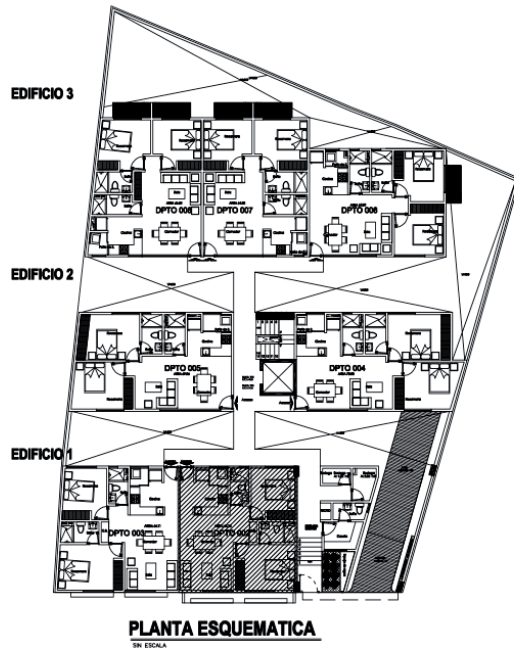

- Deptos desde 64 hasta 70 m<sup>2</sup>
- 2 recámaras
- 2 baños
- Área de servicio
- Cocina equipada
- Sala comedor
- Balcón (algunos)

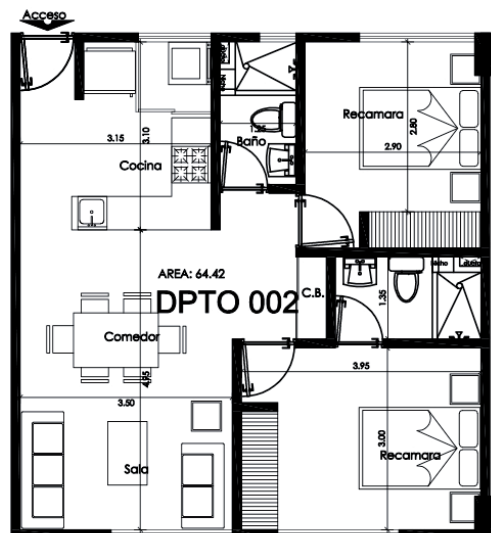



# N1

## Departamento tipo 101 al 108

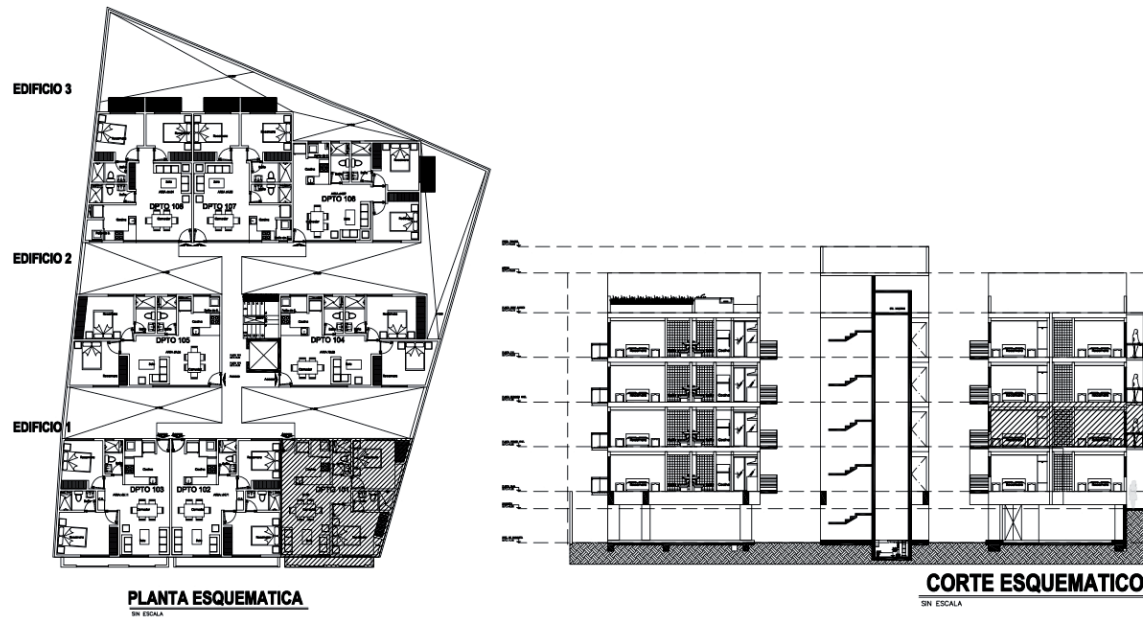

- Deptos desde 67 hasta 70 m<sup>2</sup>
- 2 recámaras
- 2 baños
- Área de servicio
- Cocina equipada
- Sala comedor
- Balcón (algunos)

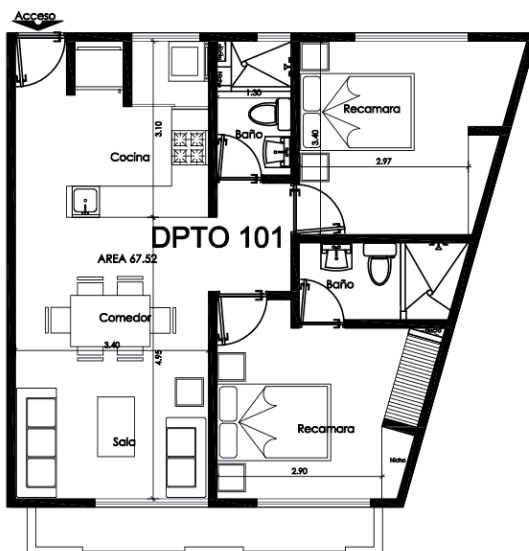

# N2

## Departamento tipo 201 al 208

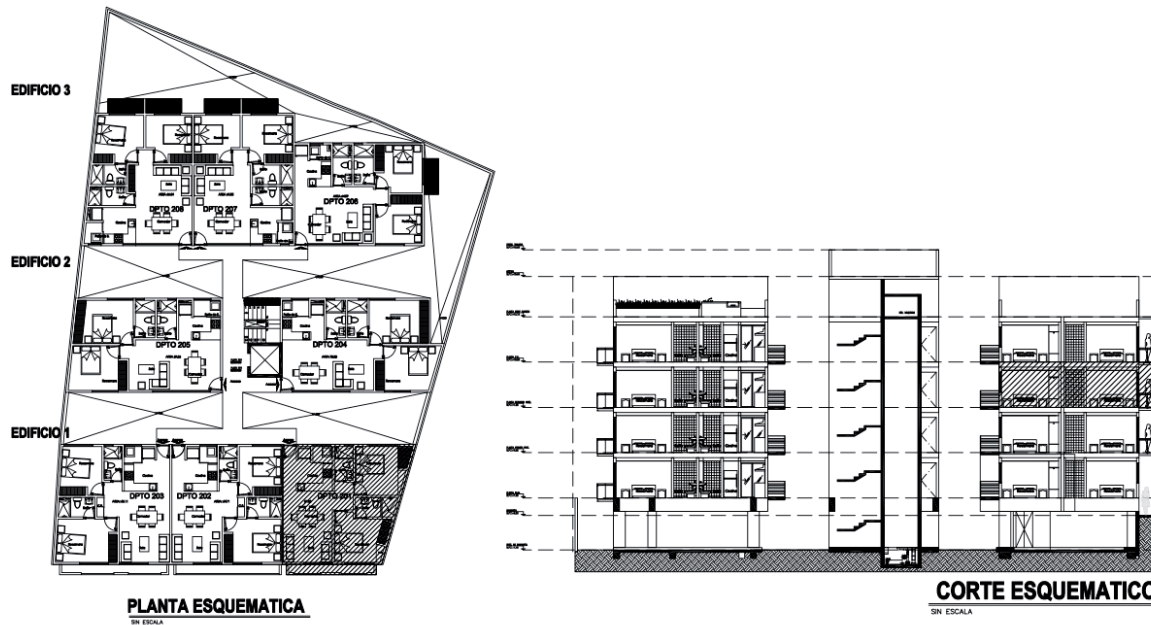

- Deptos desde 67 hasta 70 m<sup>2</sup>
- 2 recámaras
- 2 baños
- Área de servicio
- Cocina equipada
- Sala comedor
- Balcón (algunos)

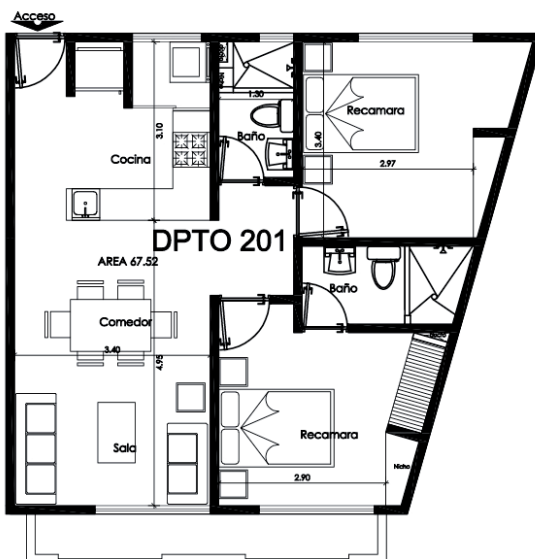



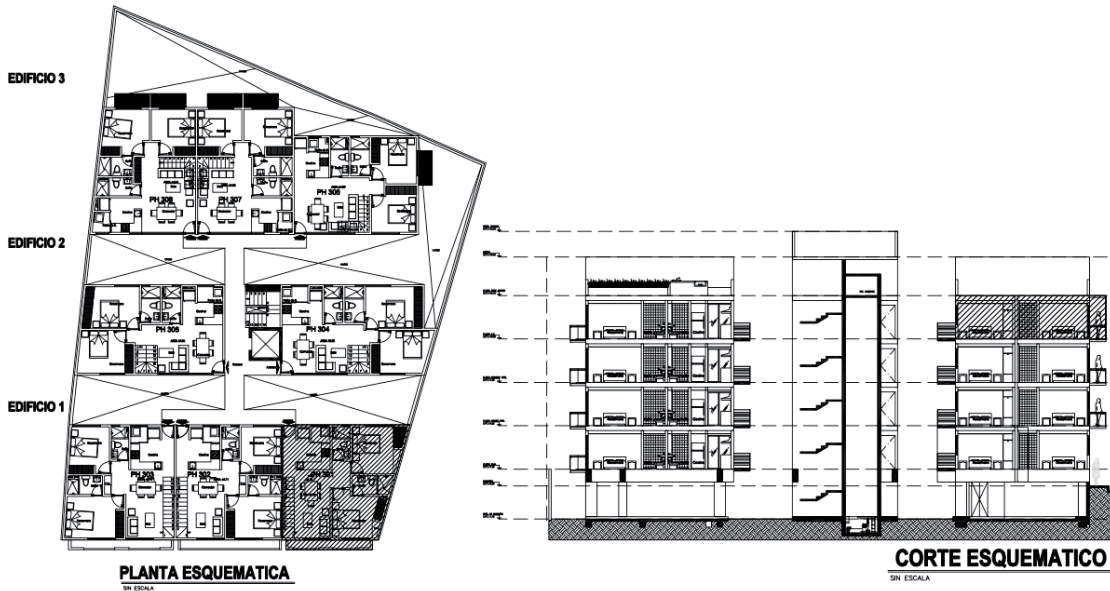

- Deptos desde 67 hasta 70 m<sup>2</sup>
- 2 recámaras
- 2 baños
- Área de servicio
- Cocina equipada
- Sala comedor
- Balcón (algunos)

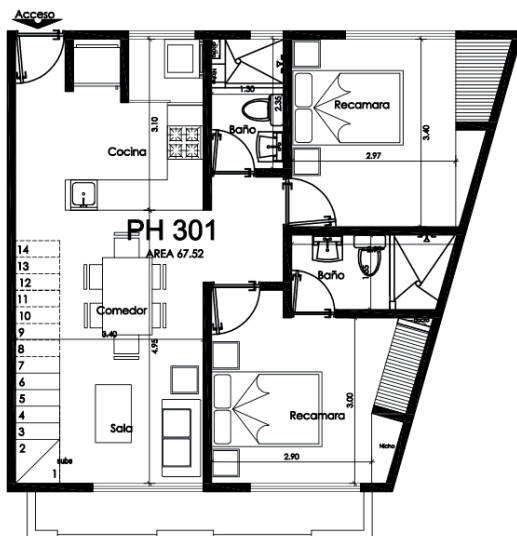

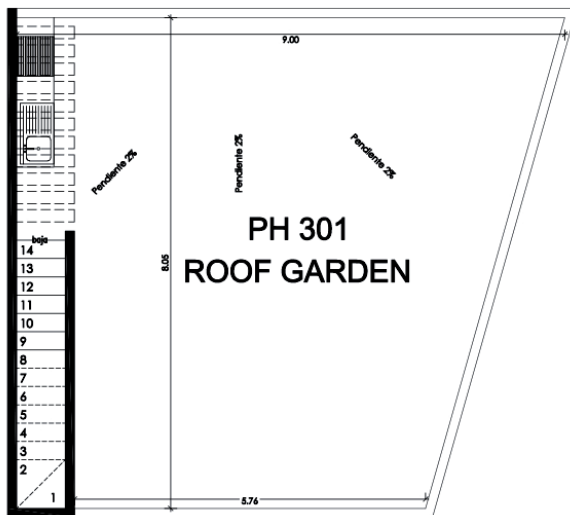
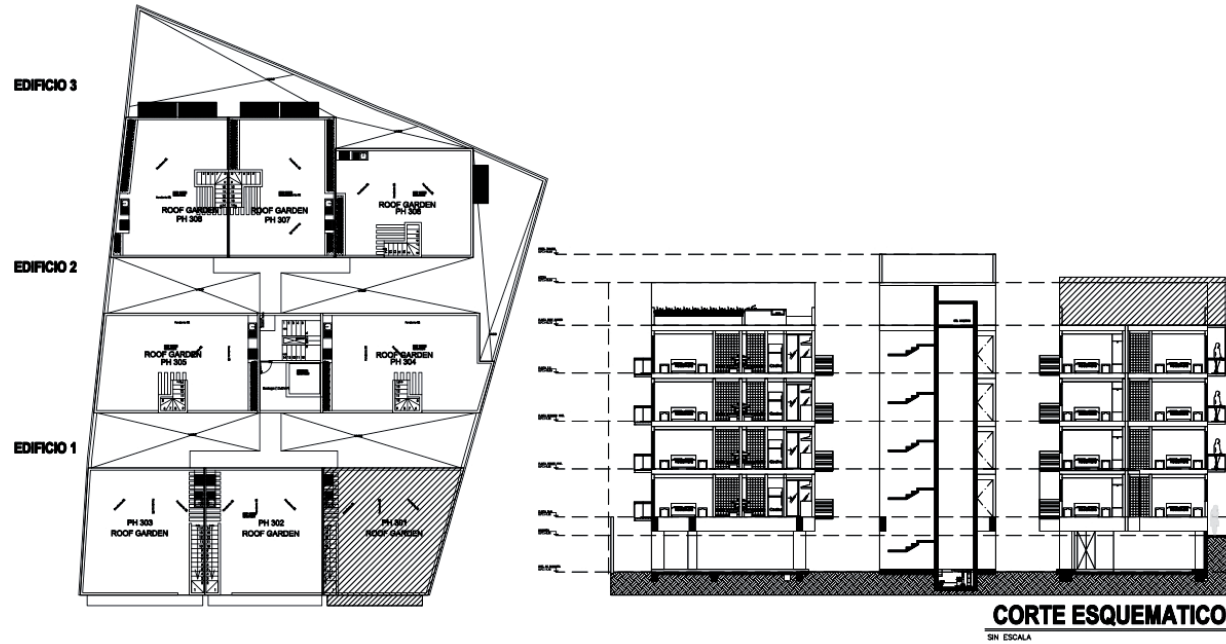

- Roof Garden privado desde 67 hasta 70 m<sup>2</sup>



# BODEGAS

DESIERTO DE LOS LEONES 5329

BODEGAS SEMI SOTANO

| BODEGAS DE USO PRIVATIVO |                     |
|--------------------------|---------------------|
| BODEGA # 1               | 4.88 m <sup>2</sup> |
| BODEGA # 2               | 2.76 m <sup>2</sup> |
| BODEGA # 3               | 4.41 m <sup>2</sup> |
| BODEGA # 4               | 4.43 m <sup>2</sup> |
| BODEGA # 5               | 4.18 m <sup>2</sup> |
| BODEGA # 6               | 4.31 m <sup>2</sup> |
| BODEGA # 7               | 3.17 m <sup>2</sup> |
| BODEGA # 8               | 3.74 m <sup>2</sup> |
| BODEGA # 9               | 3.44 m <sup>2</sup> |
| BODEGA # 10              | 3.14 m <sup>2</sup> |
| BODEGA # 11              | 3.45 m <sup>2</sup> |

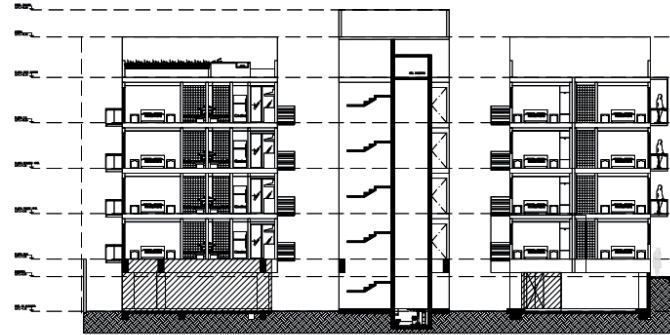

**CORTE ESQUEMATICO**  
SIN ESCALA

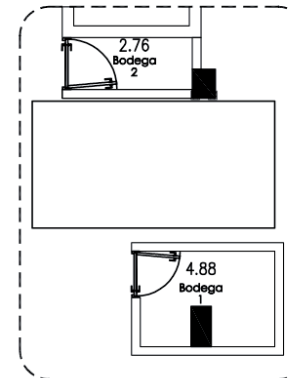
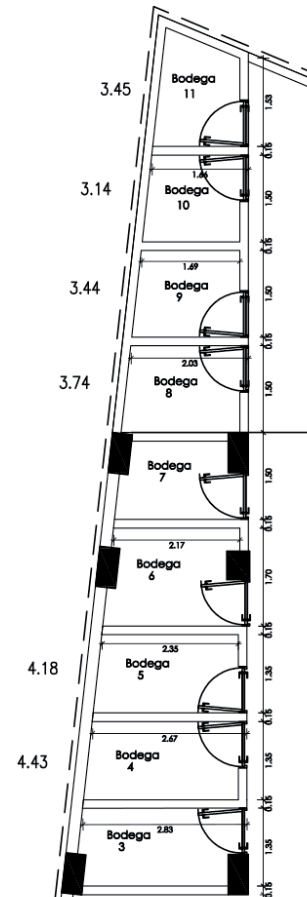
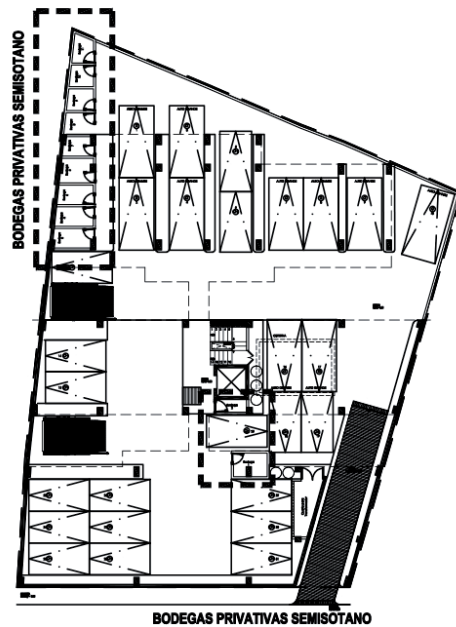

# UNA EMPRESA DE GRANDES LOGROS





# NUESTRA HISTORIA

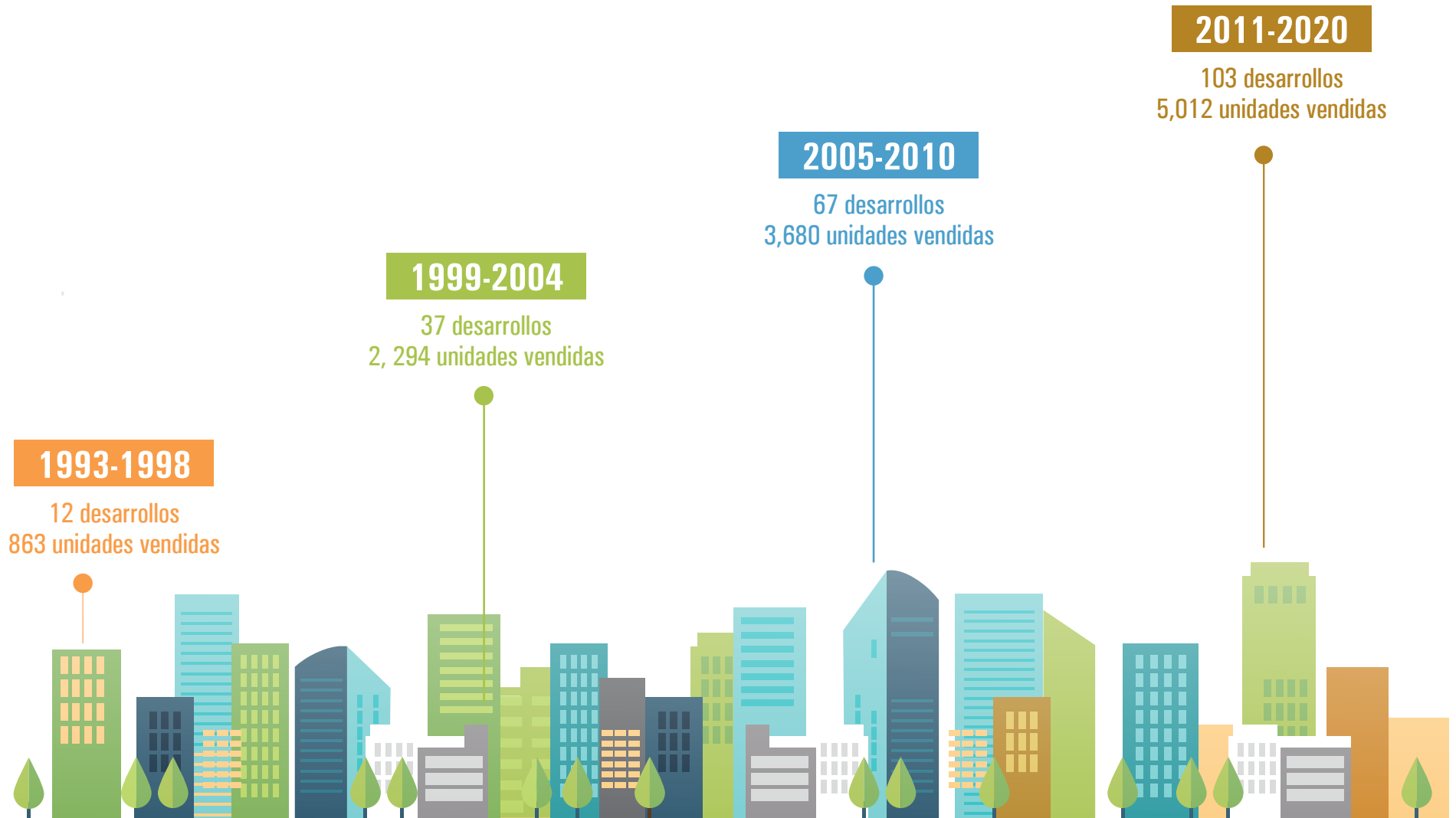



**¡Queremos que estrenes tu departamento!**  
Estamos listos para acompañarte y continuar exitosamente con tu proceso.

