

TABLA DE SUPERFICIES	
CARRO CHICO	05, 06, 07, 10, 13, 14
CARRO GRANDE	08, 09, 11, 12
CARRO GRANDE ELEVA AUTOS	01, 02, 03, 04

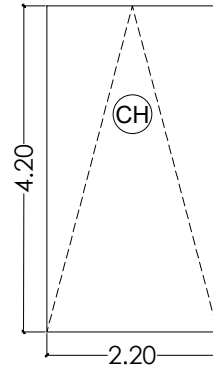

CAJON CHICO

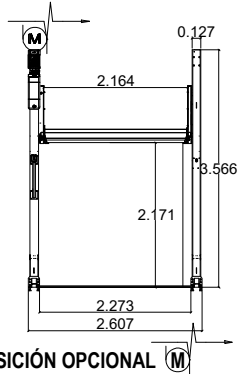
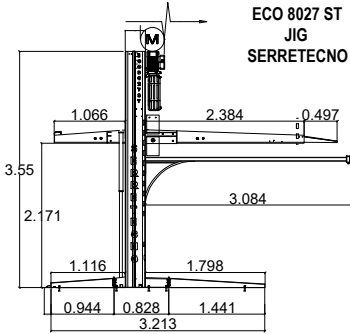
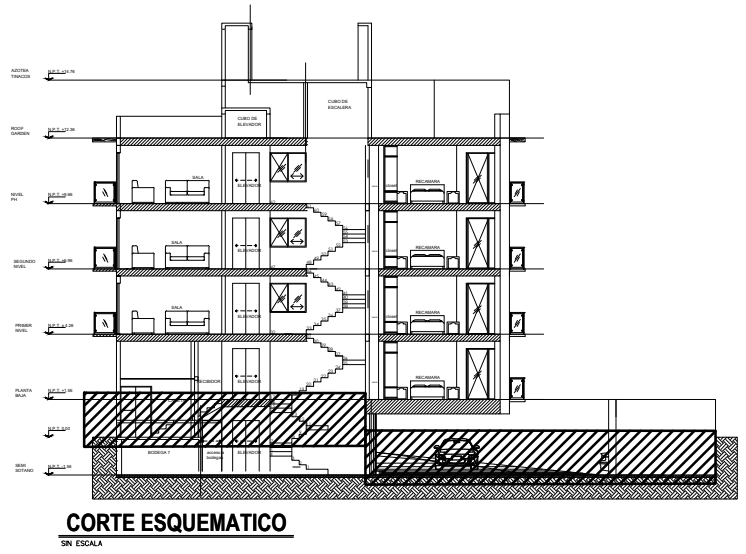
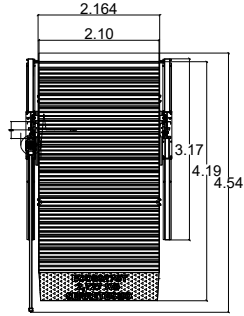
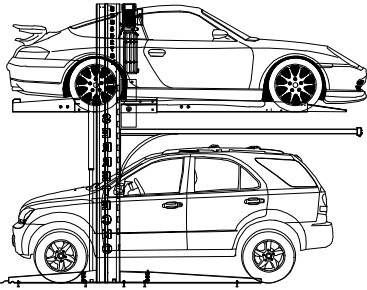
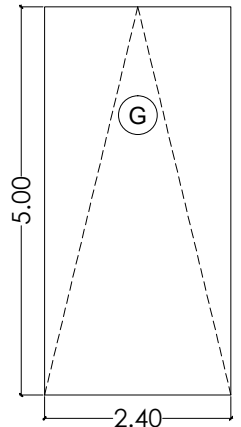

CAJON GRANDE

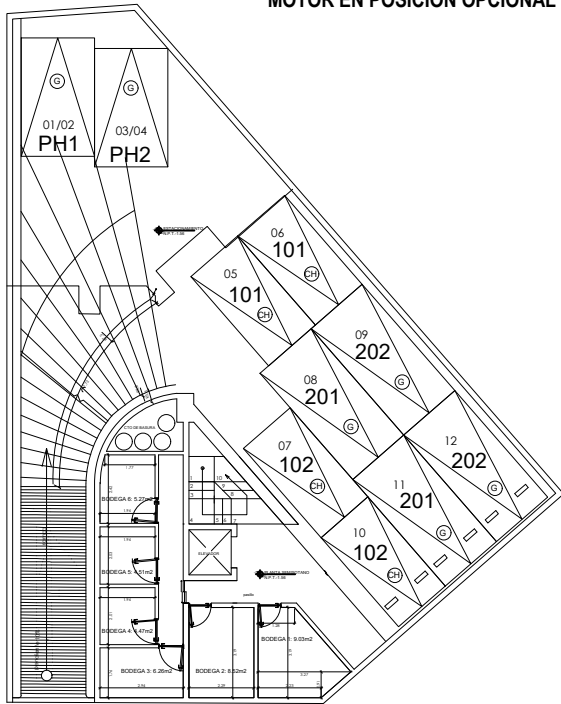

-1 PLANTA SEMISOTANO

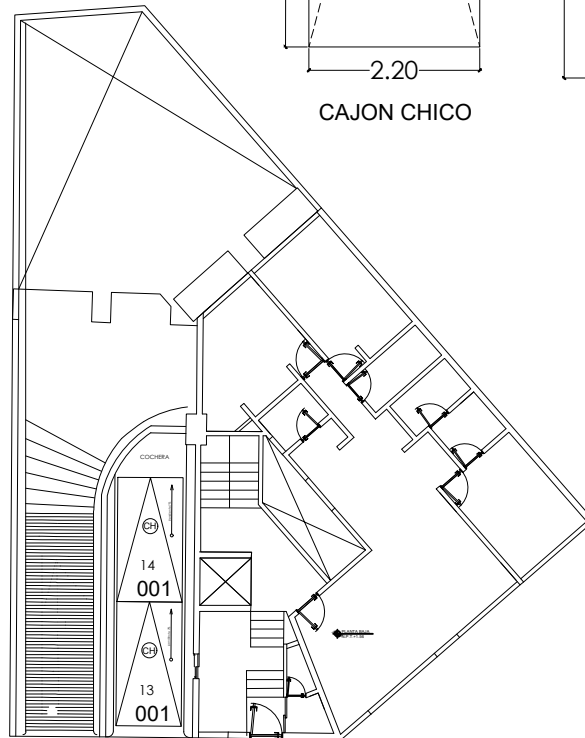

0 PLANTA BAJA

PROYECTO: DAR ARQUITECTURA		DIBUJO:	ESCALA: S/ESCALA	FECHA: AGOSTO DE 2019
CLAVE DE DEPIDO: ESTACIONAMIENTO	NIVEL: SEMI SOTANO N.P.T.: -1.56	TIPO DE PLANO: ARQUITECTÓNICO		
PLANO: PLANO ARQUITECTÓNICO		CLAVE DEL PLANO: D-SS-ESTACIONAMIENTO		